

# Sinterit ATEX Vacuum Cleaner

## USER MANUAL



Read the instruction manual before using the device.



The machine is supplied with: User manual, Test Sheet, Warranty Slip, Approval Certificate.

This manual provides all the information needed to use and service your Sinterit ATEX Vacuum Cleaner. Good operation and durability depend on proper maintenance and careful use.

Before leaving the factory, this particular model has undergone thorough tests to ensure the utmost reliability. However, make sure that the vacuum cleaner has not been damaged during transport in a way that could affect its operation and safety.

This manual should be considered an integral part of the vacuum cleaner and must be kept together with the unit until this is scrapped. In case of loss or damage to the manual, ask Sinterit for a new copy or visit [www.sinterit.com/support-page/](http://www.sinterit.com/support-page/) and download the PDF.

The subjects addressed in this manual are those expressly required by „**Machinery Directive 2006/42/CE**” and the technical details shown are those provided by the manufacturer at the time of compilation. **For ATEX Vacuums, the reference directive is the 2014/34/EU.**

This manual must be kept in a place accessible to all the personnel charged with operating and servicing the vacuum cleaner.

Before using the machine, prepare and train yourself by reading this manual carefully. Use of the machine by untrained and unauthorised persons is forbidden. The employer must inform and train the user according to the provisions of applicable laws.

Failure to observe basic safety regulations and warnings could cause accidents during vacuum cleaner operation, maintenance and repair. Operators should be aware of potential hazards and be trained and skilled enough. They should also have the right tools.

SINTERIT shall under no circumstances be deemed liable for accidents or damage caused by use of the vacuum cleaner by personnel not properly trained or who use it in an improper manner, as well as by even partial failure to comply with the safety regulations and intervention procedures indicated in this manual.

In case of any doubts, always immediately call the Sinterit Support.

## Table of contents







1. Marking text conventions used in the document .....	3
2. Contents of the Sinterit ATEX Vacuum Cleaner pack.....	4
3. Sinterit ATEX Vacuum Cleaner.....	5
A. Description .....	5
B. Specification .....	6
4. Exceptional risks.....	8
5. Important safeguards and warnings.....	8
A. Environment and place of installation.....	8
B. General safety rules .....	8
C. Personal protection .....	9
D. Power supply.....	9
E. Safety requirements during using the vacuum cleaner.....	10
F. Safety during repair and maintenance .....	11
G. Toxic and dangerous materials.....	11
H. Safety plates (specification tag and symbols) .....	12
I. Scrapping.....	13







- 6. Initial startup of the Sinterit ATEX Vacuum Cleaner after delivery..... 14
- 7. Preparing the machine to work ..... 17
  - A. Preparing the machine to work without Sinterit Powder Separator ..... 16
- 8. Information and tasks while powder suction ..... 17
- 9. Cleaning of the Filtering chamber ..... 18
- 10. Maintenance of the Sinterit ATEX Vacuum Cleaner ..... 20
  - A. General safety warnings during maintenance jobs ..... 20
  - B. Periodical maintenance ..... 21
  - C. Replacing the Main Star Filter ..... 22
- 11. Troubleshooting..... 24
- 12. General legal information..... 25
- 13. Disclaimer ..... 25
- 14. Trademarks ..... 25
- 15. Terms of warranty..... 26
- 16. Technical support..... 26

## 1. Marking text conventions used in the document

Listed below are descriptions of symbols used on the device. They constitute a warning or convey the information to protect the user, other individuals or surrounding objects and ensure correct and safe use of the device.

	<p><b>WARNING!</b> An inevitably dangerous situation which can result in serious injury or even death. Initiation, omission of a specific procedure or inattention can cause severe physical injury to the user.</p>
	<p><b>ATTENTION!</b> Initiation or omission of a specific procedure can cause physical damage to the equipment or the user.</p>
	<p><b>WARNING!</b> Risk of electric shock which can be fatal or cause severe burns. An inevitably dangerous situation which can result in serious injury or even death, if not mitigated. Before working with any equipment, you should be aware of the dangers associated with the flow of electric current, and become familiar with the standard procedures to prevent accidents.</p>
	<p><b>CAUTION!</b> Beware of moving parts which can crush hands.</p>
	<p><b>ATTENTION!</b> Risk of electric shock. A grounding is used in the vacuum cleaner. Follow the instructions in the User manual and the markings on the vacuum cleaner.</p>
	<p><b>WARNING!</b> Avoid fire! Powder dust is flammable.</p>



	<b>STOP!</b> Action prohibited.
	<b>ATTENTION!</b> It is necessary to wear antistatic clothes and shoes. Mandatory action when working with Sinterit ATEX Vacuum Cleaner.
	<b>ATTENTION!</b> It is necessary to wear protective gloves and a face mask. Mandatory action when working with powder.
	<b>IMPORTANT!</b> Information essential to correctly perform a specific task.
	<b>IMPORTANT!</b> You must read the instructions before taking action.

## 2. Contents of the Sinterit ATEX Vacuum Cleaner pack

- The Sinterit ATEX Vacuum Cleaner,
- a package for the additional equipment.

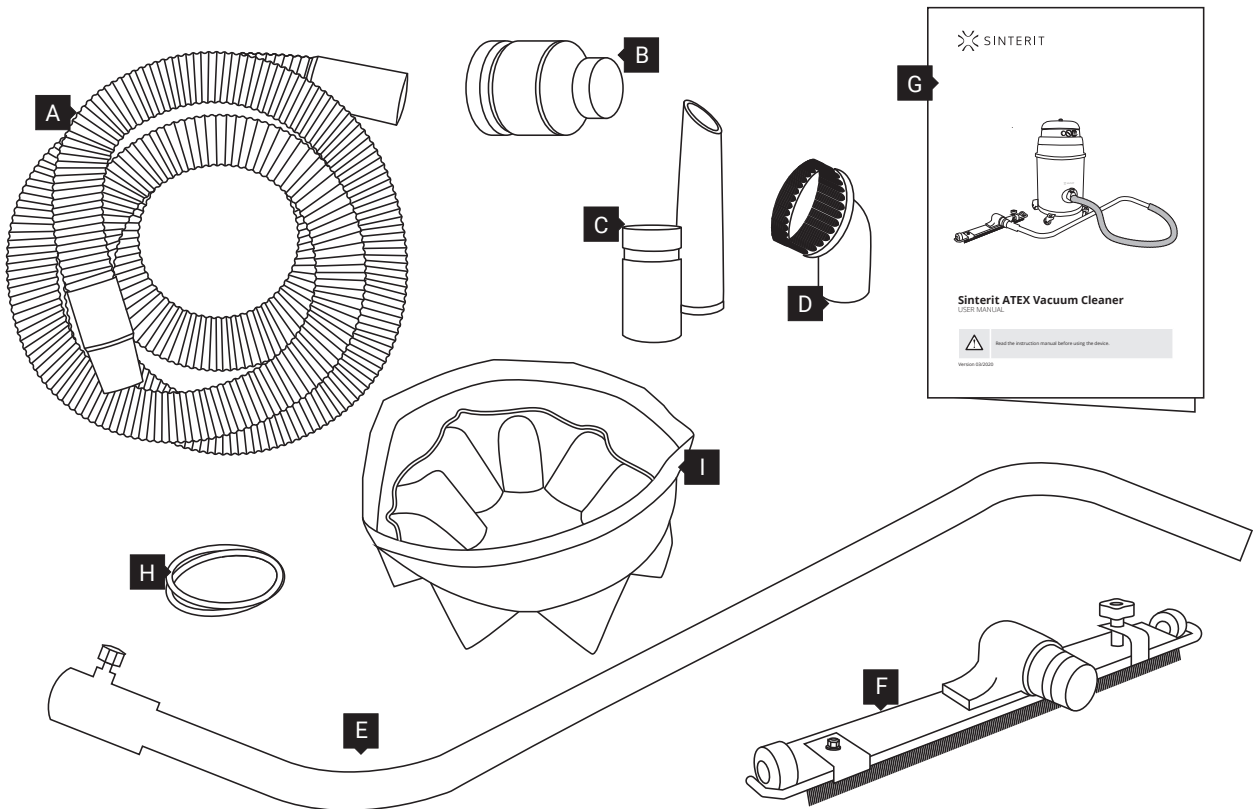

Image 1. Contents of the Sinterit ATEX Vacuum Cleaner Additional accessories box.

**A. Antistatic hose (3 m) / B. Aluminium connector 40/50 (for Antistatic hose) / C. Rubber nozzle (with aluminium connector) / D. PVC brush / E. Double curved wand / F. Floor brush / G. Sinterit ATEX Vacuum Cleaner User Manual / H. Spare Filter gasket / I. Spare Star Filter**



### 3. Sinterit ATEX Vacuum Cleaner

#### A. DESCRIPTION

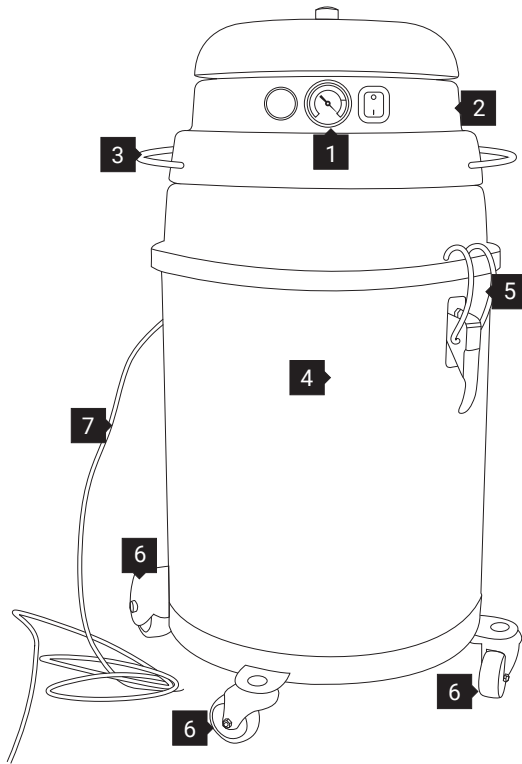

Image 2. Front view of the Sinterit ATEX Vacuum Cleaner.  
1. Control panel / 2. Motor Head / 3. Motor Head handle /  
4. Filtering chamber / 5. Release fasteners / 6. Castors /  
7. Grounding system (external wire with grounding clamp)

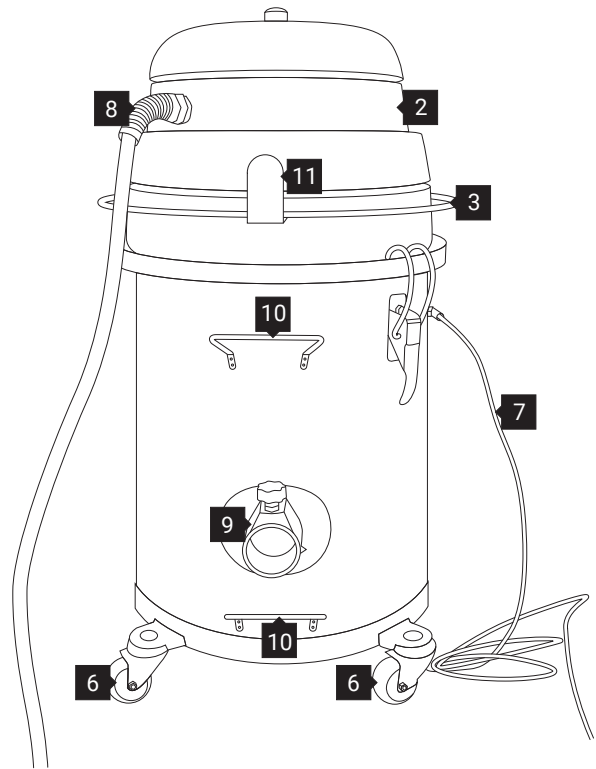

Image 3. Back view of the Sinterit ATEX Vacuum Cleaner.  
8. Power cable / 9. Suction hose connector /  
10. Filtering chamber's handles /  
11. Power cable hanger

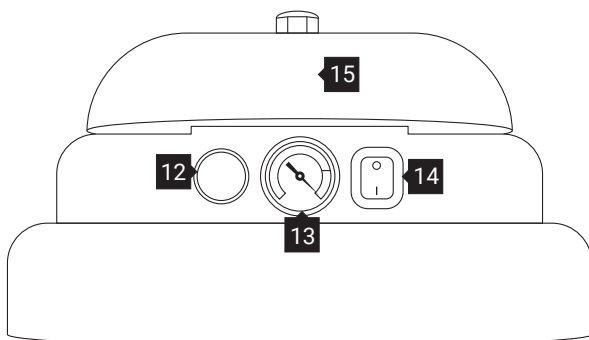

Image 4. View of the Control panel  
12. Clogged filter – green light indicator /  
13. Pressure gauge / 14. Power switch /  
15. Motor Head's protection cap

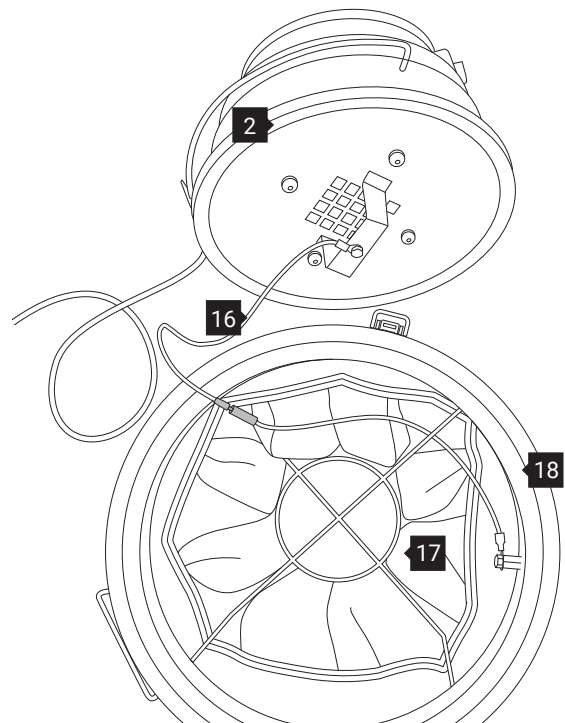

Image 5. View of the Sinterit ATEX Vacuum Cleaner's internal chamber.  
16. Internal grounding wire with connector /  
17. Main Star Filter (8 pockets) / 18. Filter gasket

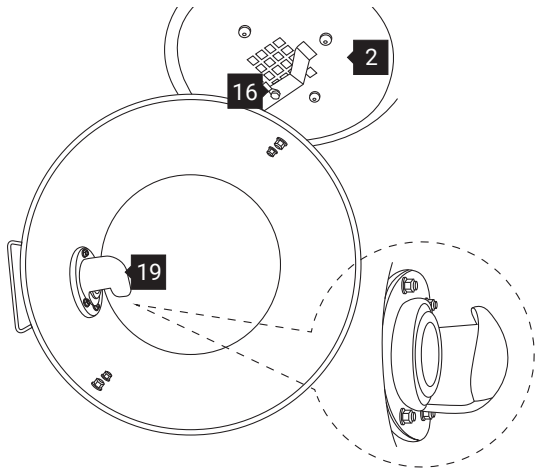

Image 6. View of the Sinterit ATEX Vacuum Cleaner's internal chamber (without filter).  
**19.Non-sparkling deflector**

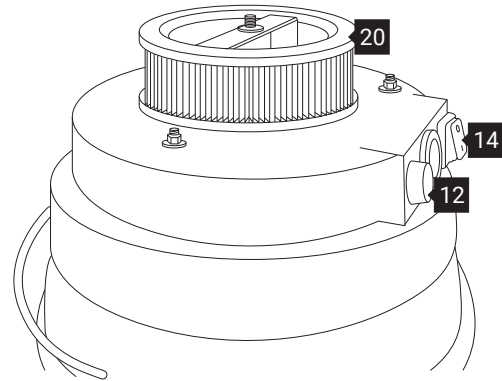

Image 7. View of the Motor head without Motor head's protection cap.  
**20.HEPA filter**

## B. SPECIFICATION:

Sinterit Atex Vacuum Cleaner available in options:

- 110 i 230 V with ATEX Z22 certification and Shuko plug with 10 [m] long cable;  
 \*on order Swiss-plug or UK-plug
- 110 V with Intertek certification with Intertek approved plug ME320P4 with 10 [m] long cable.

Waiting time depends on the selected option.

GENERAL	
<b>Category</b>	Vacuum cleaner
<b>Type</b>	Industrial
PACKAGING	
<b>Size of package</b>	570 x 670 x 1300 [mm] (22.4 x 26.4 x 51.2 [in])
<b>Package weight</b>	30 [kg] (66.13 [lbs])
<b>Package contains</b>	Sinterit ATEX Vacuum Cleaner + set of accessories + Manuals
POWER	
<b>Voltage</b>	230 [V] AC, 50/60 [Hz] or 110 [V] AC 50/60 [Hz]
<b>Power</b>	1.1 [kW]
TECHNICAL DATA	
<b>Dimensions</b>	440 x 420 x 780 [mm] (17.3 x 16.5 x 30.7 [in])
<b>Weight</b>	25 [kg] (55 [lbs])



<b>Noise level (*) (EN ISO 3744)</b>	77 [dB(A)]
<b>Max. air flow</b>	215 [m <sup>3</sup> /h]
<b>Max. vacuum rate</b>	2250 [mmH <sub>2</sub> O]
<b>Suction inlet</b>	50 [mm]
<b>Motor cooling filter</b>	2 x E10 [CAT]
<b>Air exhaust filter</b>	E10 [CAT]
<b>FILTRATION</b>	
<b>Filter type</b>	Star
<b>Surface</b>	4000 [cm <sup>2</sup> ]
<b>Diameter</b>	360 [mm]
<b>Material - Efficiency</b>	Polyester - ANT. M [IEC 60335-2-69]
<b>Capacity of collection unit</b>	40 [L]
<b>SAFETY</b>	
<b>ATEX zones</b>	Z22
<b>Marking</b>	EX II 3D T135°C
<b>Certificates</b>	CE, FCC

(\*) Noise level

Noise level readings were taken in accordance with the provisions of **Machinery Directive 2006/42/CE** standards. Sound tests performed on this specific vacuum cleaner model have been taken from a distance of 1 meter and from a height of 1.60 meters, showing an acoustic pressure no higher than the one indicates in the table.

The vibrations transmitted by the machine are lower than 2,5 m<sup>2</sup>/s.



**ATTENTION!**

Pursuant to articles L.D. 81/08, workers exposed to sound pressure levels above 85 dB (A) must be protected by special individual protection devices. It is therefore necessary, if such working conditions exist, to provide workers with such approved individual protection devices and to inform them of the risks relating to noise exposure.



## 4. Exceptional risks

Careful analysis of risks performed by the manufacturer and stored in the technical file has made it possible to eliminate most of the risks associated with vacuum cleaner operation.

The manufacturer advises to carefully follow the instructions, procedures and advice contained in this manual as well as applicable safety regulations, including the use of the provided protection devices, both those integrated in the cleaner and individual.

Possible exceptional risks:

- Electrical maintenance risks caused by the need to work under power. Only trained personnel should work on the machine with the power supply connected and this must have double earth insulation.
- Risk of improper use in the presence of explosive and flammable substances. The vacuum cleaner must not be used in environments containing substances in the form of liquids that could evaporate at room temperature and flammable dust and gas.
- Risks of operation in humid environments. Keep to the limits shown in this manual at chap. "Allowed environmental conditions".
- Risk of misinterpretation of the safety pictograms. Having identified the various outstanding risks, the manufacturer has affixed to the cleaner a number of hazard labels in compliance with regulations relating to the graphic symbols to be used. The user must immediately replace any safety plates that become illegible due to wear or damage.

### Applied directives

The following directives apply to the vacuum cleaner described in this manual:



- 2006/42/CE Machinery Directive
- 2014/30/EU Electromagnetic compatibility directive
- 2014/35/EU Low-voltage directive
- For ATEX Vacuums: 2014/34/EU ATEX Directive

## 5. Important safeguards and warnings

### A. ENVIRONMENT AND PLACE OF INSTALLATION





	<p><b>WARNING!</b></p> <ul style="list-style-type: none"><li>• The vacuum cleaner must be positioned protected against atmospheric agents (rain, hail, snow, fog, dusts in suspension, etc.) with an environmental running temperature between 5°C and 45°C and relative humidity not above 70%.</li><li>• The work environment must be clean, well-enough lit and devoid of explosive atmosphere.</li><li>• Remove the filter and clean it, empty the container and store the vacuum cleaner in a place protected against atmospheric agents with a temperature between 0°C and 40°C.</li><li>• Cover with a nylon sheet to prevent accumulation of dust.</li></ul>
---	--

### B. GENERAL SAFETY RULES



	<p><b>WARNING!</b></p> <ul style="list-style-type: none"><li>• Only adults should use the vacuum cleaner.</li><li>• When using the machine, mind other people, especially children.</li></ul>	
	<p><b>WARNING!</b></p> <ul style="list-style-type: none"><li>• The vacuum cleaner must not be operated in a corrosive or explosive environment.</li><li>• Avoid prolonged contact with solvents and inhaling their vapours.</li><li>• Avoid using the device close to open flames or sources of heat.</li></ul>	







	<p><b>ATTENTION!</b></p> <ul style="list-style-type: none"><li>• Risk of crushing upper limbs while fitting and locking the material container on the vacuum cleaner.</li><li>• Never place hands between the Filtering chamber and Motor Head while locking.</li><li>• Do not put hands on the sides of the container near the guide pins while locking.</li><li>• Perform the container locking operation by means of the levers located on the side, <b>USING BOTH HANDS!</b></li></ul>	
	<p><b>ATTENTION!</b></p> <p>When restoring original working conditions, the appointed personnel should make sure that at the end of the operating procedure, proper vacuum cleaner operation safety conditions are restored, especially the safety devices and the protective guards.</p>	
	<p><b>WARNING!</b></p> <ul style="list-style-type: none"><li>• Never leave miscellaneous materials on the horizontal protection cap.</li><li>• The Motor Head's protection cap containing moving parts must not be removed by the user.</li><li>• Make sure all the guards and protection devices are in place and that all the safety devices are in place and working properly.</li></ul>	





## C. PERSONAL PROTECTION

	<p><b>ATTENTION!</b></p> <ul style="list-style-type: none"><li>• The operator must always wear antistatic clothes and shoes.</li><li>• The floor of the area to be vacuumed must be antistatic.</li></ul>	
	<p><b>STOP!</b></p> <p>Do not wear loose or hanging clothing such as ties, scarves or torn garments that could become trapped and be sucked up by the cleaner.</p>	





## D. POWER SUPPLY

	<p><b>WARNING!</b></p> <ul style="list-style-type: none"><li>• In case your machine's code plans a SCHUKO plug, and not the traditional industrial single phase IP67 plug, it's necessary to connect it in a NOT CLASSIFIED ATEX zone.</li><li>• Before plugging in, make sure the power voltage and frequency are those shown on the machine plate.</li><li>• In the event of an extension being used, make sure this is in perfect condition, marked CE and that the cross section of the cable is suitable for the vacuum cleaner power input.</li><li>• During use, mind the power supply cables and avoid crushing or pulling these.</li><li>• Periodically check the mains power cable to ensure it is not damaged.</li><li>• In the event of the cable, plugs or couplings being replaced, make sure these are protected against water spray and check mechanical strength.</li><li>• Motor brushes and burnt-out fuses must be replaced by Sinterit or authorised dealers. Always use original spare parts.</li></ul>	
---	---	---







	<b>STOP!</b> <ul style="list-style-type: none"><li>• Never touch electric wires, switches, buttons, etc. with wet hands.</li><li>• In the event of the cable being damaged, the machine must not be used.</li><li>• Never pull the machine by means of the power cable and the vacuum hose.</li></ul>	
	<b>ATTENTION!</b> <ul style="list-style-type: none"><li>• Make power connections to a mains supply with an efficient earth system.</li><li>• In case of vacuums with the grounding system, connect the grounding clamp with a conductive surface connected with the earth.</li></ul>	

## E. SAFETY REQUIREMENTS DURING USING THE VACUUM CLEANER



	<b>WARNING!</b> <p>Always make sure the vacuum cleaner is free of all external materials such as debris, oil, equipment and other objects that could affect operation and cause injury to persons.</p>
	<b>ATTENTION!</b> <ul style="list-style-type: none"><li>• During vacuuming operations, always lock the brake of the vacuum cleaner using the special revolving castors lock.</li><li>• Use the machine cautiously on slopes and ramps.</li><li>• Do not change direction on gradients.</li></ul>
	<b>STOP!</b> <ul style="list-style-type: none"><li>• Climbing on the vacuum cleaner is forbidden.</li><li>• Do not release the vacuum/pressure relief valve.</li><li>• Do not open the vacuum container with the machine running.</li></ul>
	<b>WARNING!</b> <p>The opening of the Filtering chamber container must be executed in a non-classified atmosphere area, after having disconnected and unplugged the machine and only after 10 minutes from unplugging.</p>
	<b>WARNING!</b> <p>These specific vacuum cleaner models have been designed, built and protected for vacuuming dusts and solid materials only, using special filters.</p> <p>For ATEX vacuums, antistatic filters are used according to <b>ATEX Directive 2014/34/EU</b>.</p> <ul style="list-style-type: none"><li>• Always use specific filters for the type of dust or materials to be vacuumed! Any other use is considered IMPROPER. The vacuum cleaner is in any case intended for professional industrial use.</li><li>• Never use the vacuum cleaner without the filter.</li><li>• Do not vacuum lit cigarette ends. The filter could be damaged.</li><li>• If the filters are correctly fitted, the machine will not eject any objects.</li></ul>



## F. SAFETY DURING REPAIR AND MAINTENANCE

	<p><b>WARNING!</b></p> <ul style="list-style-type: none"><li>• All maintenance operations must be executed in a non-classified atmosphere.</li><li>• Only skilled persons should carry out repairs.</li><li>• Read the operator's and maintenance manual carefully before using the cleaner or doing any maintenance jobs.</li><li>• During cleaning operations, maintenance jobs or when changing parts, the starter switch must be off and the machine must be unplugged by removing the cable from the socket.</li><li>• During maintenance jobs, affix a notice to the appliance indicating „MACHINE BEING SERVICED, DO NOT START“.</li></ul>
	<p><b>STOP!</b></p> <p>Avoid using flammable or toxic solvents such as petrol, benzene, ether and alcohol for cleaning.</p>
	<p><b>WARNING!</b></p> <ul style="list-style-type: none"><li>• Structural damage and improper alterations or repairs could change the protection capacity of the vacuum cleaner and therefore cancel this certification.</li><li>• Any alterations to the appliance can only be made by Sinterit Support.</li><li>• In the event of Customers fitting a tool to the machine not supplied by Sinterit, make sure the safety conditions required by <b>Machinery Directive 2006/42/CE</b> are complied with and in any event, Sinterit is unable to accept liability for any problems arising from use of such tool.</li></ul>
	<p><b>WARNING!</b></p> <p><u>NON-SPARKING DEFLECTOR</u></p> <p>The vacuum cleaner is provided with a rubber non-sparking deflector that avoids potential ignition sources within the container and allows working with safety in case of Zone 20 generation inside the container. Check the deflector conditions every month.</p>



## G. TOXIC AND DANGEROUS MATERIALS

	<p><b>STOP!</b></p> <ul style="list-style-type: none"><li>• Using the machine to vacuum toxic substances is forbidden.</li><li>• Do not vacuum flammable materials or substances or which could cause explosions (fuels, solvents, petrol etc.).</li><li>• Do not suck lighted cigarettes, cigarette stubs or incandescent or burning materials.</li><li>• Do not vacuum sources of ignition.</li><li>• Do not vacuum corrosive substances unless the machine is equipped with containers suitable for this purpose (Stainless-steel AISI 304).</li><li>• The user is responsible for disposing of vacuumed substances in accordance with applicable laws.</li></ul>	
	<p><b>STOP!</b></p> <p>The user is responsible for disposing of vacuumed substances in accordance with applicable laws.</p>	



## H. SAFETY PLATES (SPECIFICATION TAG AND SYMBOLS)

Plates showing safety symbols and/or messages are attached to the vacuum cleaner.. most of the risks associated with vacuum cleaner operation.

	<p><b>ATTENTION!</b></p> <ul style="list-style-type: none"> <li>• Make sure all the safety messages are legible.</li> <li>• Clean these with a cloth, soap and water. Do not use solvents, diesel fuel or petrol.</li> <li>• Replace the damaged plates with new ones supplied by Sinterit. If a plate is attached to a replaced part, make sure a new plate is affixed to the new part.</li> <li>• In compliance with the Machinery Directive 2006/42/CE on vacuum cleaners, the machine is fitted with CE plates.</li> <li>• When contacting the manufacturer or dealer, always quote the details shown on the vacuum cleaner plate.</li> </ul>
	<p><b>WARNING!</b></p> <p>Removing the safety plates on the vacuum cleaner is strictly forbidden! The manufacturer declines all liability in relation to vacuum cleaner safety in the event of failure to comply with the above indications.</p>







 <p>Conforma to UL Std UL73, UL1017, UL232301 Cart. to CSA Std C22 2#68, C22 2#243, C22 2#213</p> <p><b>delfin</b> Strada della Merla 49/A 10036 Settimo Torinese (TO) ITALY ph. +39 011 800 55 00 f. +39 011 800 55 06 delfin@delfinvacuums.it www.delfinvacuums.it</p>	<p><b>ATEX</b>  <b>CE</b></p>
<p>MOD: <input type="text" value="Sinterit ATEX Vacuum Cleaner"/></p> <p>ELECT. RATING: <input type="text" value="104-127V, 60 Hz, 14A, 1.1KW, 1PH"/> S/N: <input type="text" value="200218356"/></p> <p>AMBIENT TEMP. RANGE: <input type="text" value="0°C ≤ T ≤ +40°C"/> MONTH/YEAR: <input type="text"/></p> <p>OPERATING TEMP.: <input type="text" value="T3C, T160°C"/> FILTER: <input type="text" value="M"/></p> <p>MARKING: <input type="text" value="CLASSII • DIVISION 2 • GROUPS FG"/></p>	<p>MOD: <input type="text"/> S/N: <input type="text"/></p> <p> <input type="text" value="II 3D Ex iD IIIB T135°C X IP55 Dc"/></p> <p> <input type="text"/></p>

Image 8. View of the specification tags in the Sinterit ATEX Vacuum Cleaner.



Other types of plates and symbols appearing on the vacuum cleaner.

	<p>Specific sign of conformity with the ATEX 2014/34/UE DIRECTIVE.</p>	
	<p>Caution! Do not vacuum sources of ignition!</p>	
<p><b>M</b></p>	<p><b>CAUTION:</b> this machine contains harmful vacuumed dust. Emptying operations, including the removal of the collection container after due waiting time must only be executed by qualified operators wearing the appropriate safety devices. Do not use the vacuum without filtering systems.</p>	<p><b>M</b></p>
<p>This plate is applied to the vacuum when the machine is equipped with a C CLASS anti-static filter (max. efficiency: 1 micron).</p>		



<p><b><u>WARNING!</u></b></p> <p><b>EXPLOSION HAZARD. DO NOT DISCONNECT WHILE THE CIRCUIT IS LIVE OR UNLESS THE AREA IS FREE OF IGNITIBLE CONCENTRATIONS.</b></p> <p><b><u>AVVERTISSEMENT!</u></b></p> <p><b>RISQUE D'EXPLOSION. NE PAS SE DÉBRANCHER LORSQUE LE CIRCUIT EST VIVANT OU SAUF SI LA ZONE EST LIBRE DE CONCENTRATIONS IGNITIABLES.</b></p>	<p><b><u>WARNING!</u></b></p> <p><b>EXPLOSION HAZARD. DO NOT CONNECT OR DISCONNECT WHEN ENERGIZED.</b></p> <p><b><u>AVVERTISSEMENT!</u></b></p> <p><b>RISQUE D'EXPLOSION. NE PAS CONNECTER OU DÉCONNECTER LORSQU'IL EST SOUS TENSION.</b></p>
---	---

## I. SCRAPPING

	<p><b>IMPORTANT!</b></p> <p>In case of scrapping, all the component parts of the vacuum cleaner will have to be disposed of through adequate disposal channels in accordance with applicable legislation. Before scrapping, all plastic and rubber parts will have to be separated from the electrical material. Parts made of plastic, aluminium and steel only may be recycled if collected by special centres.</p>	
---	---	---



## 6. Initial startup of the Sinterit ATEX Vacuum Cleaner after delivery

- The machine is supplied in a strong cardboard box secured with straps.
- Transport the package using a fork-lift truck of adequate lifting capacity and make sure it is stable and that weight is properly distributed on the forks.
- Before starting to move, make sure the transit area is free and that there are no moving objects on the packaging.
- During movement, keep the load low for greater stability and safety.
- When starting up the vacuum cleaner, move this using the supplied castors.
- The appliance must never be moved using fork-lift trucks or other equipment that lifts it off the floor.
- If for any reason there is a need to lift and transport the vacuum cleaner, this operation must be performed under the responsibility of the user. The user is therefore invited to secure the load as he best thinks fit to ensure the operation is performed safely.



### ATTENTION!

Before installing the Sinterit ATEX Vacuum Cleaner, carefully check if it hasn't been damaged during transport.

## 7. Preparing the machine to work



### ATTENTION!

In the event of any component parts being damaged, do not proceed with installation. Notify the manufacturer and reach an agreement on how to proceed.



### ATTENTION!

- The operator using the Sinterit ATEX Vacuum Cleaner always must wear antistatic clothes and antistatic shoes.
- The working environment and the floor must comply with antistatic standards.



### WARNING!

The vacuum cleaner can be shifted manually on flat grounds only. The vacuum cleaner heavy weight may not allow the operator to shift it safely on slopes as it would be difficult to handle and control the machine avoiding dangerous collisions which may cause damages and injury.

1. Set on the castors brake **6** to ensure that the machine is stable.
2. Check that the nut of the grounding system **7** (on the vacuum cleaner) is tightly screwed in.
3. Check the components inside the vacuum cleaner (Internal grounding **16**, Filter gasket **18**, Main Star filter **17**, inside the Filtering chamber **4**).
  - a. Unlock the Release fasteners **5** between the filtering chamber **4** and the Motor Head **2**.
  - b. Grab the Motor Head handle **3** and lift it up and put it on the floor. **Watch out! The Motor Head is very heavy!**
  - c. Disconnect the internal grounding **16** with connector **21** (Image 9) to get to the Main Star filter **17** and the Filtering chamber **4**.

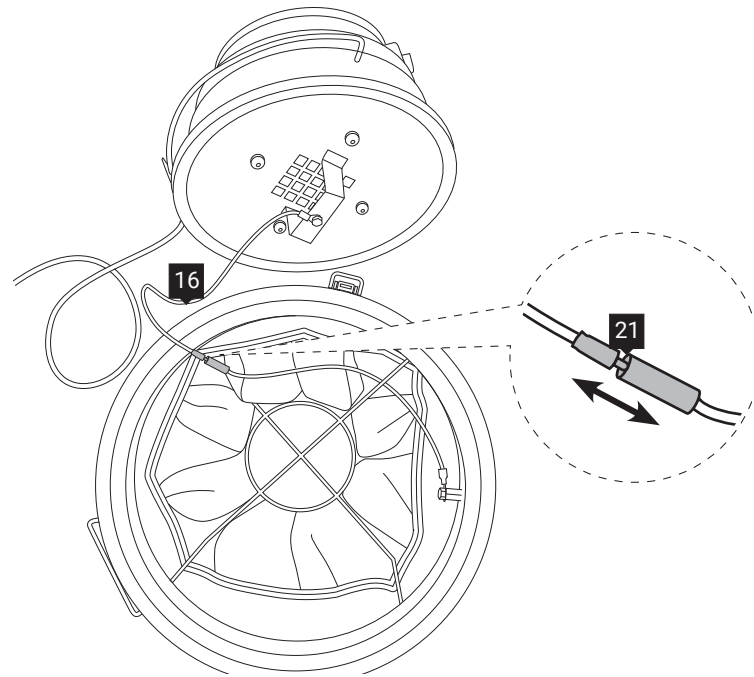

Image 9. Disconnect the internal grounding **16** with connector **21**.

- d. Check the condition of the Filter gasket **18** around the chamber.
- e. Remove the Main Star filter and check its condition.
- f. Check for unnecessary objects inside the chamber and the Non-sparking deflector **19** condition.



**IMPORTANT!**

Only the flawless condition of all components guarantees the grounding and safety using the vacuum cleaner!

4. Put the Main Star filter back in place.
5. Connect the internal grounding!
6. Fit the Motor Head to the Filtering Chamber.



**CAUTION!**

Danger of crushing upper limbs when fitting and locking the Motor Head on the Filtering Chamber.

**Now you have two options:**

- you can use ATEX Vacuum Cleaner to remove the powder from the printing chamber (using connected Sinterit Powder Separator to collect the unsintered powder);
- vacuum dust around the work area using a floor brush connected straight to the hose.

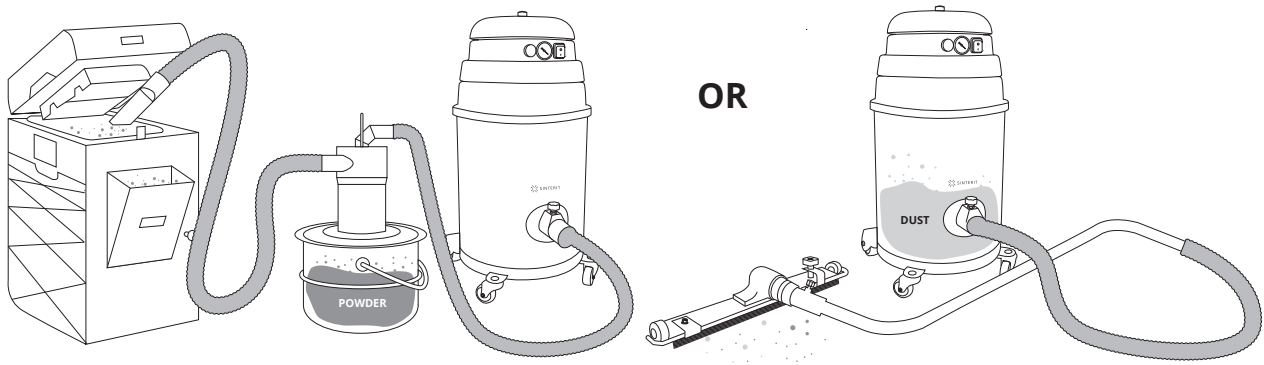

Image 10. Two ways of using the Sinterit ATEX Vacuum Cleaner.



### IMPORTANT!

For full instructions on how to use the Sinterit Powder Separator with the Sinterit ATEX Vacuum Cleaner, please refer to Sinterit Powder Separator's user manual.

## A. PREPARING THE MACHINE TO WORK WITHOUT SINTERIT POWDER SEPARATOR

1. Fit the Antistatic hose **A** into the Aluminium connector 40/50 **B** and next into the Suction hose connector **9**. At the same time, lift the locking screw of the suction hose connections (Image 10, part 1) and insert the Antistatic hose (Image 10, part 2).

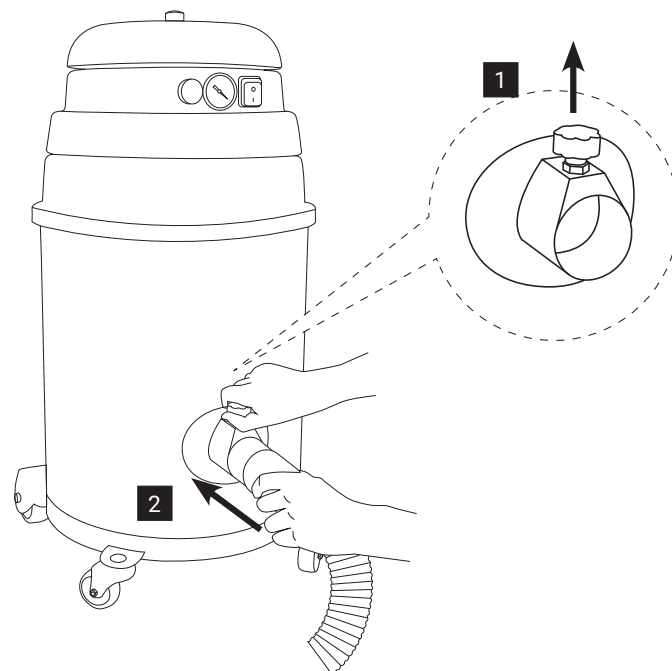

Image 10. Connecting the Antistatic hose to the vacuum cleaner.





2. Fit the accessory required for the type of vacuuming operation on the opposite end of the hose **A**.
  - For work with powder, choose: Rubber nozzle with aluminium connector **C**.
  - For cleaning the printer, choose: PVC brush **D**.
  - For cleaning the working area around the printer, choose Double curved wand **F** and Floor brush **G**.
3. Make sure the power supply corresponds to the voltage and frequency indicated on the vacuum cleaner safety plate.
4. Ensure that the Power cable **8** and the optional extension are in perfect conditions.
5. Connect the vacuum cleaner grounding system **7** to a conductive surface.
6. Plug the Power cable into the power supply.
7. Grab one end of the Antistatic hose complete with selected accessories.
8. Turn on the vacuum cleaner by switching the Power Switch **14** from "0" to "1".





9. Hold the vacuum cleaner pipe/hose tightly and start suctioning the powder from the printer or clean a device.
10. To stop the vacuum cleaner, switch the Power Switch from "1" to "0".
11. After finishing work, disconnect the vacuum cleaner grounding system **7** and Power cable **8** from the power socket.

## 8. Information and tasks while powder suction

	<b>ATTENTION!</b> During vacuuming, avoid rolling up or bending the flexible Antistatic hose and Power cable.	
	<b>IMPORTANT!</b> To move the vacuum cleaner (especially when the machine is switched on), use the Motor Head handle <b>3</b> .	
	<b>ATTENTION!</b> Before switching the vacuum cleaner back on, make sure the motors have come to a complete halt.	

1. When sucking the powder out of the printing chamber, hold the Rubber nozzle close to the surface. Do not insert in the bottom of the chamber (Image 11).
2. Do not block the hose outlet/nozzle by hand!

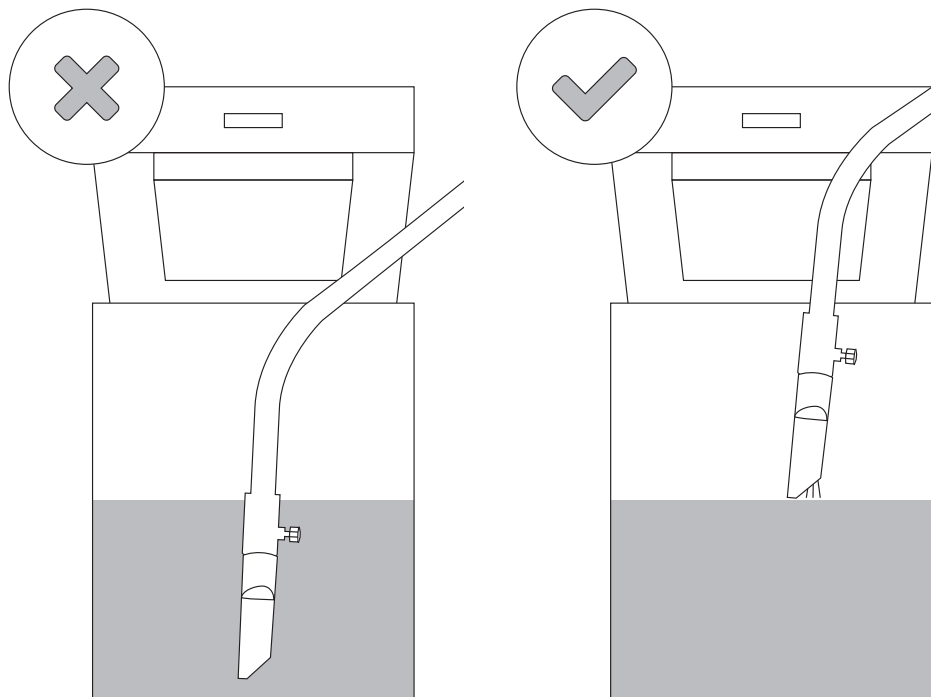

Image 11. Incorrect and correct removing the powder from the print chamber.

3. The capacity of the collected material in each device should not exceed 3/4 of the container. After each cleaning process, open the device to check the current filling level.
4. For proper operation of each device (vacuum cleaner/powder separator), it is necessary to leave some free space in the container in order to keep the air access.



**POWDER → ONLY 3/4 OF THE CONTAINER**

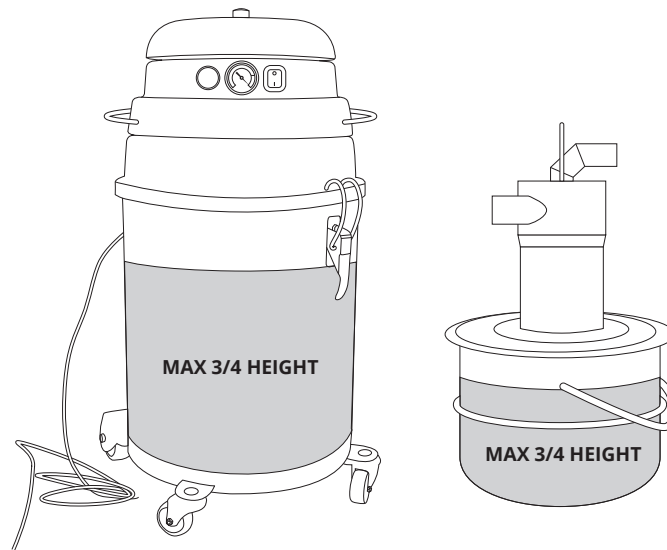

Image 12. Maximum capacity of the powder.

## 9. Cleaning the Filtering chamber

	<p><b>ATTENTION!</b> Any maintenance or cleaning job must only be executed in a <u>non-classified atmosphere</u>, which means an area with a non potentially explosive atmosphere.</p>	
	<p><b>ATTENTION!</b> Before starting any maintenance or cleaning job, always wear adequate protective clothing, eyewear, face mask, and/or gloves according to the type of job to be done.</p>	

1. Set on the castors brake to ensure that the machine is stable.
2. Turn off the vacuum cleaner by switching the Power Switch from "1" to "0".
3. Disconnect the vacuum cleaner plug from the power supply.
4. Release the Antistatic hose from the Suction hose connector.
5. Release the two Release fasteners **5** that hold the Motor Head (Image 13).
6. Lift the Motor Head and rest this on a flat surface being careful not to damage the Power cable.
7. Disconnect the internal grounding **16** from the connector **21** to get to the Main Star filter (Image 14).

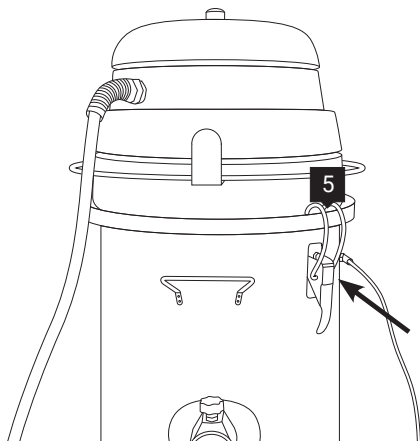

Image 13. Release the Release fasteners.

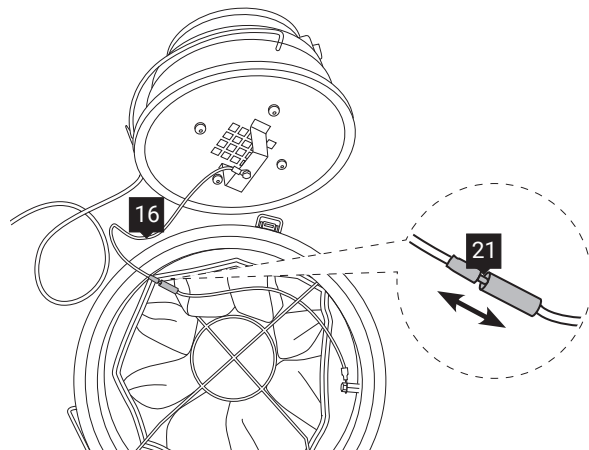

Image 14. Disconnect the internal grounding **16** with connector **21**.



8. Remove the Main Star filter. Watch out for the powder on the filter surface, especially underneath! Put the Main Star filter on a tray (you will avoid spilling powder around the area).
9. Empty the Filtering chamber from the powder or dust into special containers.



**STOP!**

Empty the contents of the Filtering chamber into a special waste disposal container in accordance with laws applicable in the country where the vacuum cleaner is used.



10. Put the Main Star filter back in place.
11. Connect the internal grounding!
12. Fit the Motor Head back on and secure with Release fasteners.



**CAUTION!**

Danger of crushing upper limbs when fitting and locking the Motor Head on the Filtering Chamber.

13. Fit the necessary accessories, connect the power supply and grounding. Start working again.



## 10. Maintenance of the Sinterit ATEX Vacuum Cleaner

This section describes the control and special maintenance operations crucial for keeping the vacuum cleaner in perfect working condition.



### **ATTENTION!**

All the transport and handling operations described in this section must be done in NOT CLASSIFIED zone, which means in an area with non potentially explosive atmosphere.



Any other jobs which might be necessary to eliminate operating faults must be expressly authorised by the manufacturer. In such cases, always notify the identification details of the cleaner. In the case of major repairs, it is best to contact an authorised dealer, whose skilled personnel, backed by all the technological experience relating to the original factory construction methods, are always available and ready to promptly intervene.

### A. GENERAL SAFETY WARNINGS DURING MAINTENANCE JOBS

Maintenance jobs must always be performed by skilled technicians, trained to carry out their specific jobs. In the case of this machine, these are mechanical maintenance and electrical maintenance. The Safety Manager has the precise duty of determining the professional capacities and skills of such persons.

Before doing any maintenance job, the safety manager must:

- Make sure there are no unauthorised people in the work area.
- Make sure the necessary tools are on hand and that these are in good condition.
- Make sure that lighting is adequate and, if necessary, provide 24-V portable lamps.
- Make sure the maintenance engineer is equipped with all approved individual protection devices needed for the specific operation (gloves, eyewear, shoes, etc.).
- Make sure the maintenance engineer has carefully read the instructions contained in this manual and knows how the vacuum cleaner works.

Work done on motors or other electrical parts must only be performed by a specifically trained electrician, authorised by the Safety Manager.

Always use tools that are in perfect condition and specifically made for the operation to be done. The use of unsuitable tools or tools not in good condition could cause serious damage.



### **ATTENTION!**

Before starting any maintenance or cleaning job, always wear adequate protective clothing, eyewear, face mask, and/or gloves according to the type of job to be done







### **ATTENTION!**

All the described operations must be done with the plug disconnected from the power socket.





## B. PERIODICAL MAINTENANCE

	<p><b>ATTENTION!</b> Any maintenance or cleaning job must only be executed in a non-classified atmosphere, which means in an area with non potentially explosive atmosphere.</p>	
<p><b>EVERY DAY</b></p>	<ul style="list-style-type: none"><li>• Make sure that the Filtering chamber <b>4</b> is not full. It is recommended to empty the Filtering chamber when the collected material fills 3/4 of its maximum capacity.</li><li>• Check the condition of the Antistatic hose <b>A</b> and other accessories to be used. Any hole, crack or fissure in the Antistatic hose will reduce suction power and disperse the vacuumed dust into the environment.</li></ul>	
<p><b>EVERY WEEK</b></p>	<ul style="list-style-type: none"><li>• Clean the vacuum regularly, removing dust deposits. The thickness of the deposited dust must not exceed 2 mm.</li><li>• Remove any layers of dust on the castors <b>6</b>.</li><li>• Check that the nut of the grounding system <b>7</b> (on the vacuum cleaner) is tightly screwed in.</li></ul>	
<p><b>EVERY 6 MONTHS</b></p>	<ul style="list-style-type: none"><li>• Check that the head basement sheath, the filter holding ring sheath (clamp) <b>22</b> and the Filtering chamber sheath are hermetic.</li><li>• The electrical units (plugs, switches, cables and so on) must have no faults or defects.</li><li>• Screws and nuts must always be tightened.</li><li>• Clean the Non-sparkling deflector <b>19</b> inside on a regular basis to prevent dust accumulation inside the Filtering chamber.</li><li>• Remove the Motor Head protection cap <b>15</b> protecting the turbine and vacuum any dust deposit within the suction unit.</li><li>• Check the filter <b>17, 20</b> conditions.</li><li>• The Main Star Filter <b>17</b> must not be too breathable.</li><li>• There must be no cuts and holes and the sewing must not be worn. Check that the Main Star Filter holding ring is tightened. In the event any of the aforesaid circumstances occur, replace the filter as indicated in section C this chapter.</li></ul>	
<p><b>MOREOVER</b></p>	<ul style="list-style-type: none"><li>• For Non-sparkling deflector <b>19</b>; please check periodically its condition. In case it's too worn, there is no guarantee of the required ATEX protection.</li></ul>	
	<p><b>ATTENTION!</b> To ensure the vacuum efficiency and safety, Sinterit recommends an overhaul at the Manufacturer's technical service workshop every 24 months.</p>	
	<p><b>ATTENTION!</b> In case of dust outflow from the engine, turn off the vacuum immediately and call the authorised service centre applying for assistance.</p>	
	<p><b>WARNING!</b> Any maintenance and repair operation not included in the above-mentioned ones must be executed by the Manufacturers technical service workshop or by Sinterit authorised service centres.</p>	



## C. REPLACING THE MAIN STAR FILTER



### ATTENTION!

Before starting any maintenance or cleaning job, always wear adequate protective clothing, eyewear, face mask, and/or gloves according to the type of job to be done.

1. Set on the castors brake to ensure that the machine is stable.
2. Turn off the vacuum cleaner by switching the Power Switch from “1” to “0”.
3. Disconnect the vacuum cleaner plug from the power supply.
4. Release the two Release fasteners **5** that hold the Motor Head (Image 15).
5. Lift the Motor Head and rest this on a flat surface being careful not to damage the Power cable.
6. Disconnect the internal grounding **16** with connector **21** to get to the Main Star filter (Image 16).

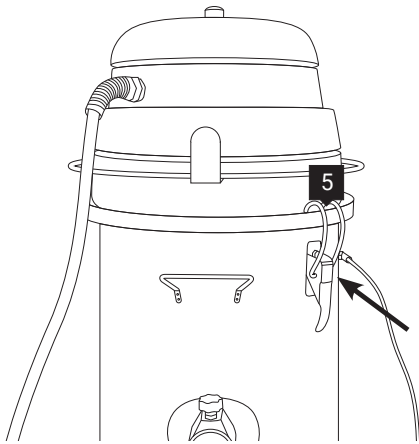

Image 15. Release the Release fasteners.

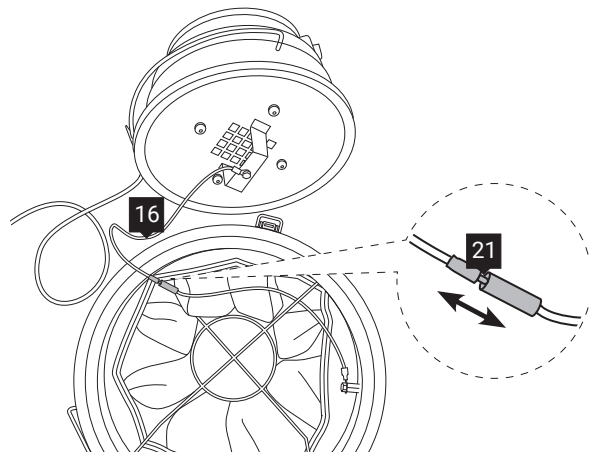

Image 16. Disconnect the internal grounding **16** with connector **21**.

7. Remove the Main Star filter. Watch out for the powder on the filter surface, especially underneath!
8. Put the Main Star filter on the work tray (you will avoid spilling powder around the area).
9. Loosen the clamp inside the filter **22** and remove the support ring with seal (Image 17).

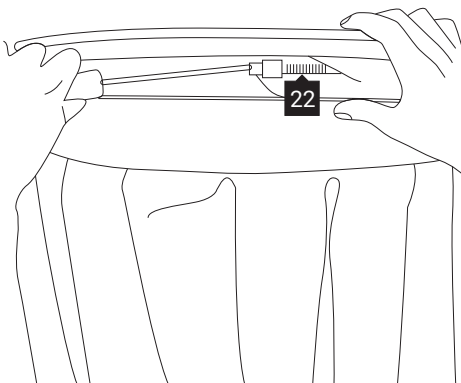

Image 17. Loosen the clamp inside the Main Star filter.

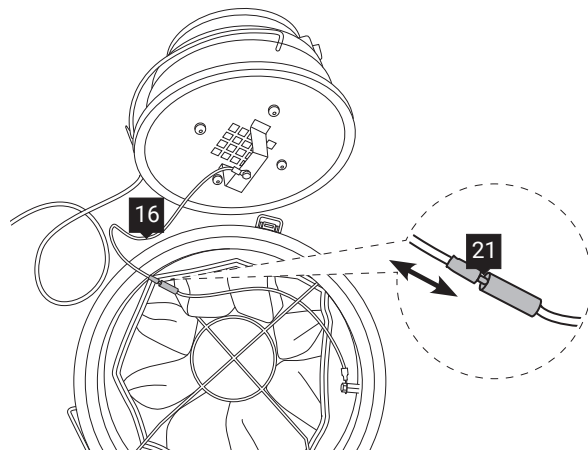

Image 18. Connecting the internal grounding.

10. Remove the knots and take out the Star filter.
11. Clean the remaining parts of the filter housing from powder.
12. Fit the new filter, put everything back together carefully and precisely.
13. Put the Main Star filter back in place.
14. **Remember to connect the internal grounding!** (Image 18).
15. Fit the Motor Head back on and secure with Release fasteners.



**CAUTION!**

Danger of crushing upper limbs when fitting and locking the Motor Head on the Filtering Chamber.



**IMPORTANT!**

All the material trapped by the filter and the filter itself must be disposed of through authorised channels in the country where the vacuum cleaner is used.





## 11. Troubleshooting

FAULT FOUND	POSSIBLE FAULT	RECOMMENDED REMEDY
<b>The vacuum cleaner fails to start.</b>	No power.	1. Check the power mains supply. 2. Check the integrity of the plug and Power cable.
<b>Dust leaking out.</b>	Perforated Antistatic hose or Double curved wand.	Replace the damaged component.
	Perforated Star filter or HEPA filter.	Replace the damaged filter.
	Filter unsuitable for type of job.	Fit a suitable filter for the type of material to be vacuumed.
<b>The vacuum cleaner does not work as it should.</b>	Antistatic hose perforated or blocked.	Check the hose and, if necessary, replace it.
	Filtering chamber full.	Empty the Filtering Chamber.
	Main Star Filter blocked.	Clean the filter and, if necessary, replace it.
	Filter gasket worn.	Check the gasket and, if necessary, replace it.
	Air leak.	Check for any air leaks out of Release fasteners, tightening screws or Filtering chamber.
<b>Motor is very noisy.</b>	Contact with Sinterit Support.	



### **ATTENTION!**

In case of any other problems, contact with Sinterit Support.





## 12. General legal information

Where this manual refers to Sinterit or the Company, this means Sinterit sp. z o.o. with its legal seat in Krakow, registered by the District Court for Kraków-Śródmieście in Krakow, XI Commercial Division of the National Court Register under number: 535095, NIP (tax number): 6793106416, with the share capital for a date of publication of this manual of PLN 83,750 (say: eighty-three thousand seven hundred fifty).

This document contains material protected under copyright and industrial property laws. This means that the document may not be, including but not limited to, reproduced or modified without the consent of Sinterit.

This manual serves to assist you in the correct use of the device, perform basic maintenance and, if necessary, to solve simple problems, allowing you to maintain the device in a good condition.

This manual contains content exclusively for the provision of information and the use by individuals professionally trained and engaged in the operation and maintenance of the equipment described below.

The information contained in this document is intended for use only with the product called Sinterit ATEX Vacuum Cleaner.

Due to the constant development of Sinterit's products the information contained in this manual, specifications and markings are subject to change without notice.

## 13. Disclaimer

Sinterit is not responsible for any use of this information in relation to other products.

Sinterit is not liable for any damages, including but not limited to losses or lost profits, resulting from the use of any materials (consumables) other than those provided to the purchaser by Sinterit.

Sinterit is not liable to the purchaser of the product or any third party for any damages, including but not limited to losses or lost profits resulting from improper use of the product, particularly not in accordance with this manual, or modifications or repairs unauthorised by Sinterit or improper maintenance.

Although every effort has been taken to provide accurate information about the product, Sinterit assumes no responsibility for any incorrect information or omission. Sinterit reserves the right to correct any errors and disclaims any liability in situations resulting from these errors.

Further limitations or exclusions of Sinterit's liability may result from the applicable laws or agreements entered into with the purchaser of the products.

## 14. Trademarks

Sinterit logo is a registered trademark of the Company.



## 15. Terms of warranty

The terms of the warranty are set forth in the agreement between the buyer and the Company.

In case of a purchase made in the Sinterit online shop, the terms of the guarantee are specified in the Terms and Conditions, subject to the acceptance of the Customer before placing an order.

In case of purchases made outside the Sinterit online store, the warranty terms may be specified in the offer, or in another form chosen by the Company to provide the customer with relevant information before making a purchase decision.

Sinterit's warranty does not cover including but not limited to:

- damages, abnormalities or malfunction caused by a client or any third party,
- damages, abnormalities or malfunction caused by inappropriate use, effects of force, insufficient or inappropriate maintenance, abnormal operating conditions, incorrect installation or inadequate servicing,
- damages, abnormalities or malfunction caused by dismantling, alterations, tuning or other changes of the product by a client or any third party made without written consent of Sinterit,
- damages, abnormalities or malfunction caused by or related to use of consumables other than those being supplied by Sinterit,
- damages, abnormalities or malfunction caused by or related to use of product against instructions/manuals or safety regulations,
- damages or abnormalities Sinterit is not liable for, according to the applicable law,
- damages exceeding the price paid by the client,
- costs incurred by the client in connection with the conclusion of the product sale agreement as well as storage and/or insurance of products,
- damages of property caused by the defect of the product,
- loss of profits,
- incidental, indirect, consequential damages.

The warranty does not cover any cleaning of working parts



## 16. Technical support

The latest information, technical support and versions of the manual are available by contacting us through:

- email: [www.sinterit.com/support-page](http://www.sinterit.com/support-page)
- phone: +48 570 702 886

The list of distributors and technical support in specific countries can be found at [www.sinterit.com/contact](http://www.sinterit.com/contact)



<b>ATEX</b> 	<b>CE</b>
MOD: <input type="text"/>	S/N <input type="text"/>
 <input type="text" value="II 3D Ex iD IIIB T135°C X IP55 Dc"/>	
 <input type="text"/>	

DESIGNATION	EXPLOSION-PROOF FEATURE	DEFINITION
<b>II</b>	Equipment group	The explosion-proof device intended for use in plants other than mines.
<b>3D</b>	ATEX Category	In a 22 powder explosion hazard zone. A dusty explosive atmosphere does not occur during normal operation and, if it does, persists for a short time.
<b>Ex tD</b>	Explosion Proof & Protection Types	The device is protected by a housing „t”. Protection against excessive temperature and dust ingress.
<b>IIIB</b>	Sub-group	It can be used in an atmosphere of non-conductive dust.
<b>T135°C</b>	Temperature Classification	The glowing temperature of the dust layer or self-ignition of the dust cloud must be higher than the maximum permissible surface temperature for the device, in this case, 135°C.
<b>X</b>		The specific safe use conditions indicated in the certificate shall be followed.
<b>IP55</b>	Ingress Protection Level	Dustproof, water jet protection (12.5 l/min) poured onto the housing from either side.
<b>DC</b>	Equipment Protection Level	The increased safety level of the device. The device is designed and constructed to prevent foreseeable ignition sources which may arise during normal operation.

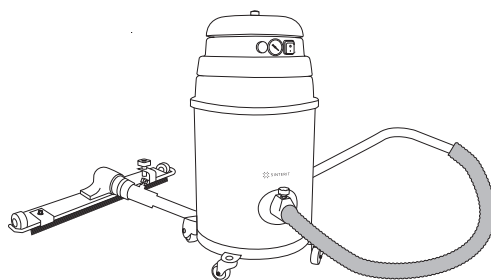

SINTERIT Sp.z o.o.  
ul. Nad Drwiną 10 bud. B3, 30-741 Kraków, Poland  
[www.sinterit.com](http://www.sinterit.com)  
Contact: +48 570 967 854